





This document set is applicable to the following part number configurations:

	<table border="1"> <thead> <tr> <th>Part Number</th> <th>Description</th> </tr> </thead> <tbody> <tr> <td>FL252</td> <td>Fuel level instrument, two tanks, 0v-5v senders</td> </tr> </tbody> </table>	Part Number	Description	FL252	Fuel level instrument, two tanks, 0v-5v senders
Part Number	Description				
FL252	Fuel level instrument, two tanks, 0v-5v senders				
	<table border="1"> <thead> <tr> <th>Part Number</th> <th>Description</th> </tr> </thead> <tbody> <tr> <td>FL253</td> <td>Fuel level instrument, three tanks, 0v-5v senders</td> </tr> </tbody> </table>	Part Number	Description	FL253	Fuel level instrument, three tanks, 0v-5v senders
Part Number	Description				
FL253	Fuel level instrument, three tanks, 0v-5v senders				
	<table border="1"> <thead> <tr> <th>Part Number</th> <th>Description</th> </tr> </thead> <tbody> <tr> <td>FL254</td> <td>Fuel level instrument, four tanks, 0v-5v senders</td> </tr> </tbody> </table>	Part Number	Description	FL254	Fuel level instrument, four tanks, 0v-5v senders
Part Number	Description				
FL254	Fuel level instrument, four tanks, 0v-5v senders				
	<table border="1"> <thead> <tr> <th>Part Number</th> <th>Description</th> </tr> </thead> <tbody> <tr> <td>FL255</td> <td>Fuel level instrument, five tanks, 0v-5v senders</td> </tr> </tbody> </table>	Part Number	Description	FL255	Fuel level instrument, five tanks, 0v-5v senders
Part Number	Description				
FL255	Fuel level instrument, five tanks, 0v-5v senders				
	<table border="1"> <thead> <tr> <th>Part Number</th> <th>Description</th> </tr> </thead> <tbody> <tr> <td>FL256</td> <td>Fuel level instrument, six tanks, 0v-5v senders</td> </tr> </tbody> </table>	Part Number	Description	FL256	Fuel level instrument, six tanks, 0v-5v senders
Part Number	Description				
FL256	Fuel level instrument, six tanks, 0v-5v senders				

# FL25X Fuel Level 0-5V

---

## THIS IS A TRANSPORT CANADA APPROVED MANUAL

---

The following checklist outlines the required articles for all FL25X series part numbers.

<b>Documentation</b>	<b>Document Number</b>
<input type="checkbox"/> Introduction (this document)	S200-FL25X-001
<input type="checkbox"/> Warranty Statement	S200-AWS
<input type="checkbox"/> Installation Instructions	S200-FL25X-002
<input type="checkbox"/> Intensity Control Installation Options	S200-DDC-INST
<input type="checkbox"/> Wiring and Installation Schematic	S200-FL25X-003
<input type="checkbox"/> Human Interface Definition	S200-HID
<input type="checkbox"/> Instrument Setup	S200-FL25X-004
<input type="checkbox"/> Operations Guide	S200-FL25X-005
<input type="checkbox"/> Product Specifications	S200-FL25X-006
<input type="checkbox"/> Installation Compliance	S200-FL25X-007
<input type="checkbox"/> Instructions for Continued Airworthiness	S200-ICA
<input type="checkbox"/> Flight Manual Supplement	S200-FMS (if applicable)
<input type="checkbox"/> Calibration Log	S200-FL25X-0XX
<input type="checkbox"/> Authorized Release Certificate	FORM ONE
<input type="checkbox"/> Permission to Use STC	S200-FL251-PTU
<input type="checkbox"/> Canadian STC and Eligibility List	STC & S200-CEL
<input type="checkbox"/> FAA STC and Approved Model List	STC & S200-AML

### Components

- FL25X Instrument
- 4 X Mounting Screws

# FL25X Fuel Level 0-5V

---

## The Fastest Way To Install And Start Using This Product

**NOTE:** *This product is certified as a primary replacement, new or secondary instrument only when installation is performed in accordance with the documented instructions and procedures.*

1. Review the Warranty Statement before performing any tasks. Do not remove the instrument from the sealed package until you agree with the stated terms.
2. If this instrument is to be installed in a certified aircraft, verify that the aircraft model is listed on the Eligibility List (Canadian registered aircraft) or the Approved Model List (USA and all other countries).

**If it is NOT listed, contact your local authority and obtain the necessary requirements or approvals before proceeding further.**

For all other vehicles, including experimental aircraft continue with Step 3.

3. Follow the Installation Instructions exactly as noted, referring to the Wiring Diagram as and when required. Note: The installation process has been optimized based on the sequence of components to be installed. Installing the product in any other way will, in all likelihood, take longer and be more complex.

Ensure that **one** of the Intensity Control options has been installed in accordance with document # S200-DDC-INST.

4. Perform the Instrument Setup using the required data as listed in the Instrument Setup procedure.
5. Validate that all functions perform as outlined in the Operations Guide.
6. Complete all regulatory documentation, if required.



## **NO NONSENSE WARRANTY**

Our warranty policy is simple .... It is even written in plain English!

**Please read it BEFORE DOING ANYTHING WITH YOUR NEW INSTRUMENT!**

**If you require technical support when installing your instrument please call our Technical Support department directly on 416-628-0725**

### **We will:**

- Repair or replace (at our discretion) any instrument which becomes defective within a period of 12 (twelve) months of manufacture date. You will pay for the shipping costs to return the instrument to us and we will pay for the shipping costs to return the instrument to you;
- Replace all instruments that fail out of warranty for a flat rate of 50% of the cost of a new instrument, at the time of the failure.

### **We are not:**

- Liable for any costs associated with the installation or removal of any of our instruments, irrespective of the cause;
- Liable for any misuse or non-use of the instrument in whatever form.

### **We will not:**

- Repair or replace your instrument free of charge, under warranty, if it has not been installed by an appropriately licensed person.

**If you do not agree with ANY of the above statements, return your new instrument to us immediately for a FULL refund LESS shipping costs.**

**ALL RETURNS REQUIRE RETURN MATERIAL AUTHORIZATIONS (RMA). WE DO NOT ACCEPT RETURNS WITHOUT RMA NUMBERS. CALL 416-628-0725 FOR AUTHORIZATION.**

# FL25X Installation Instructions

---

1. The FL25X instrument uses the existing voltage output, capacitive aircraft fuel systems for fuel level sensing. Ensure that all senders and associated electronics are in a good working condition **BEFORE** proceeding to step 2.
2. The output from the sender system must provide a voltage output relative to fuel quantity and not exceed 5.0V.
3. Connect the wiring supplied with the DB25 interface connector in accordance with the FL25X Wiring and Installation Schematic. **DO NOT ATTACH THE CONNECTOR TO THE INSTRUMENT UNTIL ALL WIRING HAS BEEN CONNECTED.**
4. Select the instrument location in the aircraft panel.
5. Ensure that the aircraft master switch and/or power to the instrument is **OFF**.
6. Attach the DB25 connector to the instrument. Ensure that the plug is fully inserted into the instrument. Finger tighten the two plug locking screws, then tighten 1/8 turn using a screwdriver. **DO NOT OVERTIGHTEN.**
7. The instrument can be installed with the DB25 connector orientated to the **TOP** or **BOTTOM** of the instrument panel.
8. Install the instrument in the panel, attaching with four 6-32 X 5/16" screws.
9. Initial Power Up Sequence:
  - a. Adjust the instrument intensity control for maximum intensity.
  - b. Apply power to the instrument.
  - c. The instrument display will light up.
  - d. The display may be inverted at this point. Ignore the orientation at this time.
  - e. Turn the instrument **OFF**.
10. If the instrument display does not light up:
  - a. Ensure intensity control is set for maximum.
  - b. Turn off power.
  - c. Disconnect the DB25 connector from the instrument.
  - d. Check intensity control.
  - e. Check the wiring installation and breaker or fuse.
11. Proceed to "Instrument Setup".

# Intensity Control – Installation Options

Applicable to Rev 05 and later 200 Series Instruments

---

Choose ONE of the options listed below for connection of the BLUE intensity control wire from the instrument harness.

## Theory of Operation

- The instrument intensity control is voltage sensitive.
- When the sense input is grounded the instrument display will be at the dimmest intensity. At bus voltage the instrument display will be at the brightest intensity.
- Voltages between these two will vary the display intensity.

### 1. Preferred Method – Independent Potentiometer

Connect the BLUE wire to P/N A200-POT Rev. 02 as below:

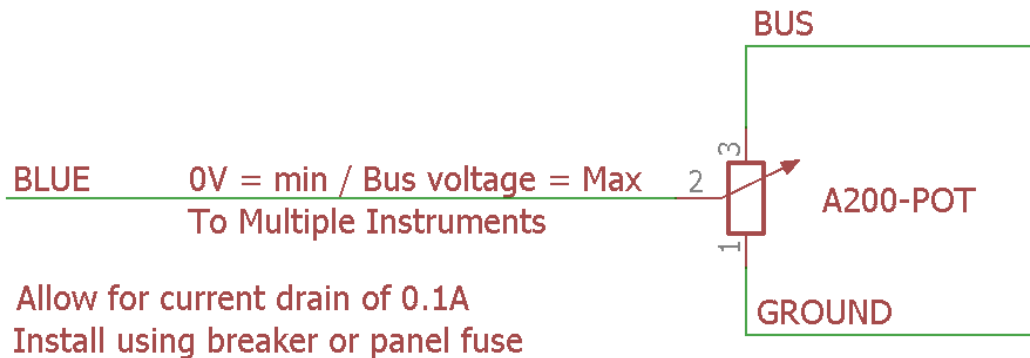

Ensure the “EXTERNAL” option in the Dimmer Control menu is set.

### 2. Connection of Existing Panel Intensity Control

Confirm the existing panel lighting control meets the following requirements:

- When set for **DAY** operation **BUS** voltage must be output.
- When used at **NIGHT** the output must vary from **0V** (Ground) to **BUS** voltage.

If these requirements are met connect the BLUE wire to the panel lighting control.

Ensure the “EXTERNAL” option in the Dimmer Control menu is set.

### 3. Day VFR Operation

Do not connect the BLUE wire. Set the intensity using the internal Dimmer Control.

Refer to document S200-HID, Intensity Control section for menu access instructions.

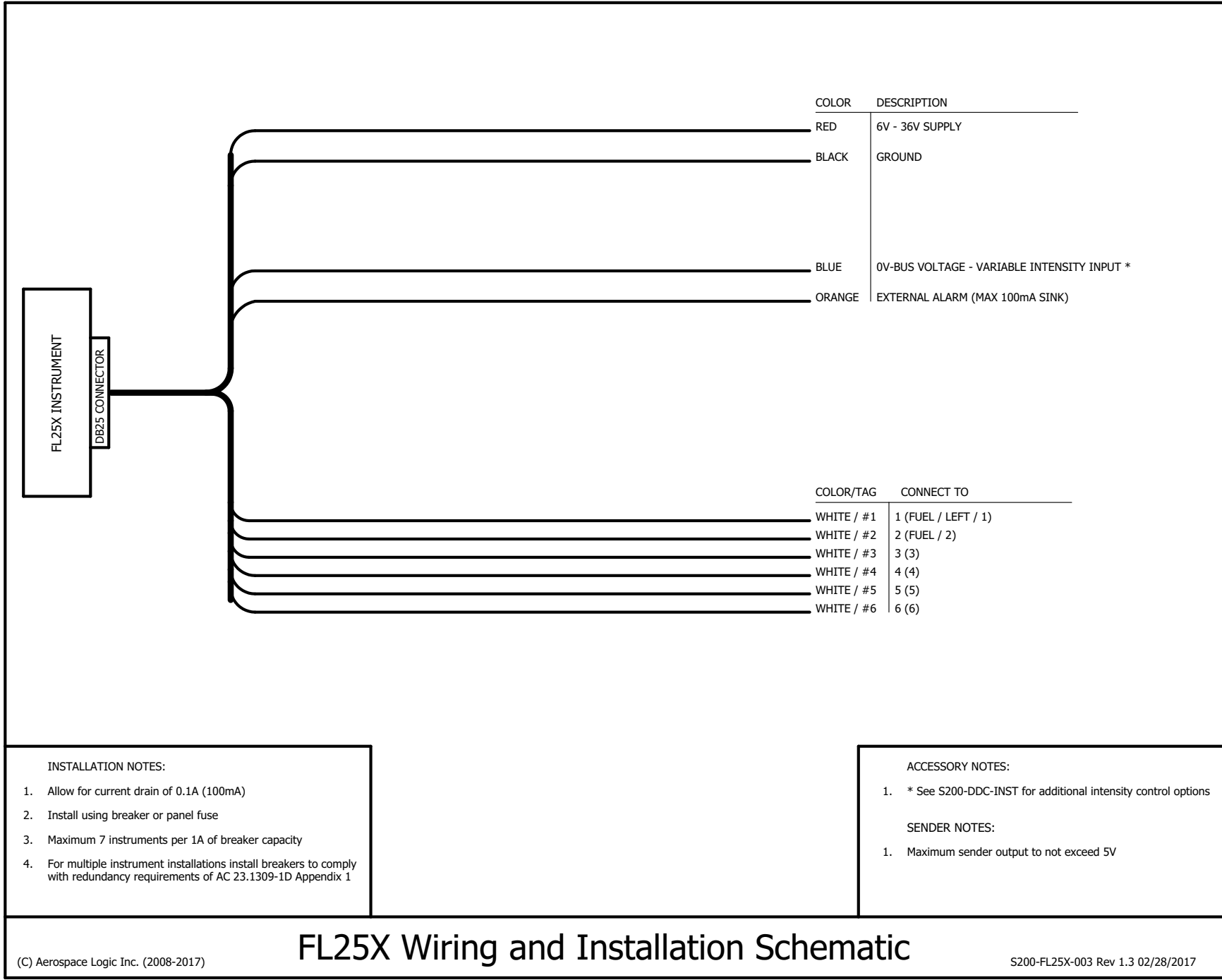

**INSTALLATION NOTES:**

1. Allow for current drain of 0.1A (100mA)
2. Install using breaker or panel fuse
3. Maximum 7 instruments per 1A of breaker capacity
4. For multiple instrument installations install breakers to comply with redundancy requirements of AC 23.1309-1D Appendix 1

**ACCESSORY NOTES:**

1. \* See S200-DDC-INST for additional intensity control options

**SENDER NOTES:**

1. Maximum sender output to not exceed 5V

# FL25X Wiring and Installation Schematic

# 200 Series Human Interface Definition

---

All 200 Series instruments have been designed around a standard Human Interface protocol. This allows identical operation of the two panel switches between all instruments while still allowing multiple functions. This document is a generic outline of the functionality of the switches, based on the various functional states of the instrument.

## Top Button

The top button is the action button. It invokes different screen displays, allows selection of values and increments or decrements values. Examples of these actions are:

1. Moving between display screens
2. Selection of an action from a menu
3. Changing a value from within the setup menus
4. Entering a value during flight (clock instrument only)

## Bottom Button

The bottom button is the navigation button. It will allow the cursor on the screen to move between allowable selections. Examples of these actions are:

1. Selection of different cylinders (EGT and CHT) in the Single Cylinder mode
2. Selection of different tanks (Fuel Level)
3. Selection of limits and functional items from within the setup menus
4. Time field selection (clock instrument only)

There is one exception to the functionality of the bottom button. This is from the Primary Display (the screen that first comes on from power up). Pressing the button will display the instrument core status and support data.

## General

1. Each instrument contains detailed button options in the Operations Guide.
2. During setup, instructions are provided on screen and use of the buttons is as noted in this document.

## Intensity Control

Press and hold the top button for 5 seconds to activate the Dimmer Control menu.

Select the "Up Arrow" and press the top button to disable external intensity and increase intensity. Select the "Down Arrow" and press the top button to decrease the intensity and enable external intensity control.

Select the "Save" option and press the top button to save your selection and return to normal operations.

The Dimmer Control menu is not available during instrument setup.



# FL25X Instrument Setup

---

1. Before proceeding with the instrument setup you will require the following information, for each tank pair or set, as it pertains to the aircraft that the instrument is being installed on:
  - a. Maximum red line fuel quantity
  - b. Maximum yellow line fuel quantity
  
2. This information must be obtained from a current, traceable source for the aircraft that the instrument is being installed on. Some possible sources are:
  - a. Pilot Operating Handbook
  - b. Maintenance Manual
  - c. Aircraft Type Certificate Data Sheet
  - d. Engine Type Certificate Data Sheet
  - e. Manufacturer
  
3. This instrument requires calibration before it will function. To calibrate each tank you will be required to add fuel at TWO gallon increments, starting with the unusable fuel in the tank (the legal, zero fuel point).
  - a. Place the aircraft in a level flight attitude and support the aircraft wings, if necessary.
  - b. Drain all tanks to be calibrated.
  - c. Disable any cross feed between tanks.
  - d. Place the unusable fuel in each tank to be calibrated.
  - e. Complete the calibration process by following the interactive, instructions provided throughout the process on the instrument display (See 4).
  - f. Calibration time is approximately one minute per two gallons of fuel.
  - g. Note the calibration values on the provided calibration sheets. This value serves two purposes.
    - i. It demonstrates a compliant installation, and
    - ii. Provides a hard copy backup of all calibration data.
  - h. It is not necessary to complete the full calibration at once. Calibration can be resumed at any point of the process by re-entering the setup.

# FL25X Instrument Setup

---

4. To enter parameters and perform the calibration, proceed as follows:
  - a. Turn off the power to the instrument
  - b. Press and hold both top and bottom buttons and turn on the power to the instrument.
  - c. When instructed, release both buttons.
  - d. In the setup menus, use the bottom button to navigate and the top button to select an option.
  - e. Follow the onscreen instructions to enter the correct operating parameters. **NOTE: Depending on the installation orientation of the instrument the display may initially be upside down. The first prompt in the setup is to press the button at the top of the instrument. This will orientate it correctly.**
  - f. To perform the instrument calibration, follow the instructions provided on the instrument screen.
  
5. Once all calibration has been completed the instrument will be enabled and be ready for use.

# FL25X Operations Guide

This manual outlines the operating procedures for all FL25X series products

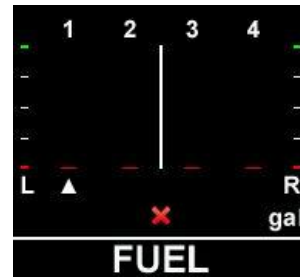
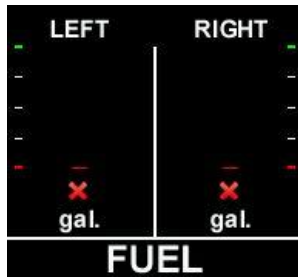

**FUEL INSTRUMENT NOT INSTALLED CORRECTLY  
FLIGHT PROHIBITED**

## 1. Power Up / Default Screen

Displays the fuel level in each tank. Colors are determined by the range values as set during installation. Tanks are indicated from leftmost to rightmost.

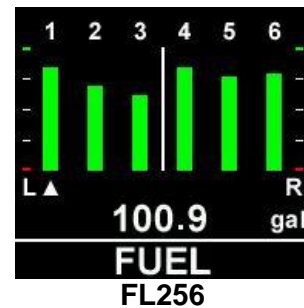
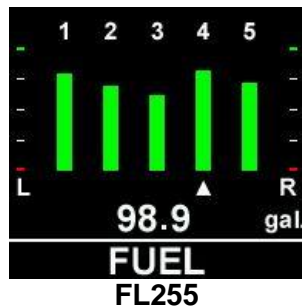
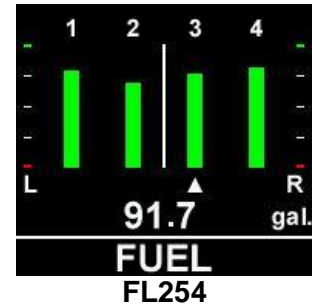
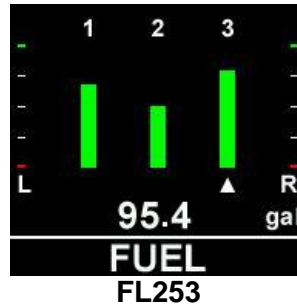
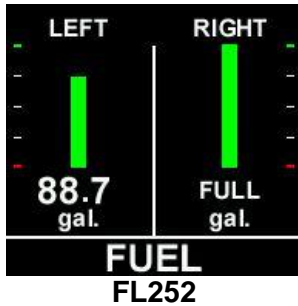

For the FL252 instrument, the quantity in each tank is permanently displayed beneath each indicator bar. For all other instruments, use the bottom button to scroll between tanks. The fuel quantity displayed corresponds to the tank number with the arrow beneath the bar indicator.

Press the top button to move to the next display screen.

# FL25X Operations Guide

---

## 2. Trend Graph

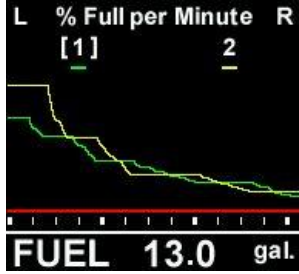

This screen provides a graphical display of fuel usage, since the most recent power on.

The graph spans a time period of 192 minutes (3 hours 12 minutes). Once this graph area has been populated it will scroll to the left.

The fuel value displayed at the bottom of the screen relates to the selected tank as indicated by the bracketed tank number at the top of the screen. Use the bottom button to scroll between tanks.

Press the top button to return to the default screen.

## 3. Other Options

To display the instrument serial number and core information press and hold the bottom button when the instrument is first powered on.

### WARNING

**NEVER RELY SOLELY ON ANY FUEL INDICATION INSTRUMENT FOR THE DETERMINATION OF AVAILABLE FUEL.**

**WHEN USED IN CONJUNCTION WITH A PHYSICAL INSPECTION, DETERMINATION OF AVAILABLE FUEL PLUS NECESSARY FLIGHT DURATION AND CONDITION CALCULATIONS, A FUEL LEVEL INSTRUMENT BECOMES A VALUABLE COCKPIT INFORMATION RESOURCE.**

### WARNING

*All operations are to be performed in accordance with the specific instructions pertaining to your aircraft, including those provided by the engine manufacturer. The FL25X series instruments are only parameter reporting devices which can assist in engine and flight management when used in conjunction with these instructions.*

*All FL25X products are certified as primary replacements **ONLY**, within the limits as described above. **THEY MAY NOT BE INSTALLED AS SECONDARY INSTRUMENTS.***

# FL25X Product Specifications

---

## Certification / Compliance

TSO	C55a
Environmental	DO-160F
	A1CAASXXXXXXXXZBXXBBBCSBA1C11XXAX
Software	DO-178B

## DC Power Source

Input voltage	6 to 36 VDC
Power consumption	100mA
Load dump tolerance	+60V
Direct spike tolerance	+/- 60V
Cable spike tolerance	> +/- 1KV

## Operating Temperature

Constant operating	-15°C to +55°C
Short term operating (1hr)	-40°C to +70°C
Storage	-55°C to +85°C

## Signal Input

Sender output	0.0V to 5.0V (DC)
---------------	-------------------

## Sender Orientation

Installer selectable. Voltage proportional or  
Inversely proportional to fuel quantity

## Display

Fuel Quantity	US Gallons or Litres
---------------	----------------------

## Accuracy

Fuel Quantity	AS405C +/- 1 USG
---------------	------------------

## Range

0 to 120 USG (defined by fuel sender/tank size)

## Display

Sunlight readable LCD  
80/80/80/80 Degree viewing angle

## Annunciator Output

100mA sink with reverse EMF protection

## Interface Connector

DB-25

## Software Functionality

Primary	Fuel level in all tanks
Trend Graph	Graphic display of level vs time

## Dimensions

2.45" X 2.45" X 0.9"

## Weight (excluding harness)

4.05 oz

## Finish

Black anodized 6061 aluminum

# FL25X Installation Compliance

---

## 1. Installation Procedures and Limitations

Should your specific aircraft not be listed on our STC Approved Model List (AML), contact your local FSDO or flight authority for installation requirements **BEFORE commencing any installation tasks.**

Installation must be in accordance with the following FL25X published documents:

- a. Installation Instructions,
- b. Wiring and Installation Schematic, and
- c. Instrument Setup.

## 2. Installation Location and Visibility

The products are to be installed in existing panel holes and will replace existing instrumentation. As primary replacement products it is recommended and preferred that they be placed in the same panel location as the original equipment. Their visibility and placement relative to other instruments are the same or similar to the existing instruments. Where they are installed in a different location it is the responsibility of the installer to ensure that they are visible to the pilot under all conditions.

## 3. TSO COMPLIANCE NOTICE

The conditions and tests required for TSO approval of this instrument are minimum performance standards. Those installing this instrument on or in a specific type or class of aircraft, must determine that the aircraft installation conditions are within the TSO standards. TSO articles must have separate approval for installation in an aircraft. The instrument may be installed only according to 14 CFR part 43 or the applicable airworthiness requirement.